



ASCO Power Technologies™

ASCO SERIES 300 Generator Paralleling System

ascopower.com



Authorized Partner



Life Is On

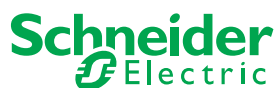

Redefining Parallel Systems



ASCO SERIES 300 Generator Paralleling System

Since introducing the first power transfer switch almost 100 years ago, ASCO has been committed to providing reliable and innovative technology, superior support and dedicated field service.

The SERIES 300 Paralleling System, available from 208 to 600 volts, is the first patented transfer switch-based paralleling system. Tested and listed per UL 891, it combines robust UL listed components in a resourceful design that brings added flexibility, reliability, and cost savings to any project.

The Patented Choice

FEATURE	BENEFIT
Unique ASCO CTTS-based design	Proven reliability and endurance
Utilizes generator power for switching	Efficient use of available power
Expert load management	Integrates ASCO's proven control technology
Compact and modular design	Minimal configuration eliminates job-specific engineering
Graphic touch screen	Provides a window to metering, event and alarm logs, bus optimization and load demand applications
Intuitive and organized user screens and controls	Ease of operation

SERIES 300 Product Components

- Generator Control Station
- Master Control Station
- Graphic Touch Screen

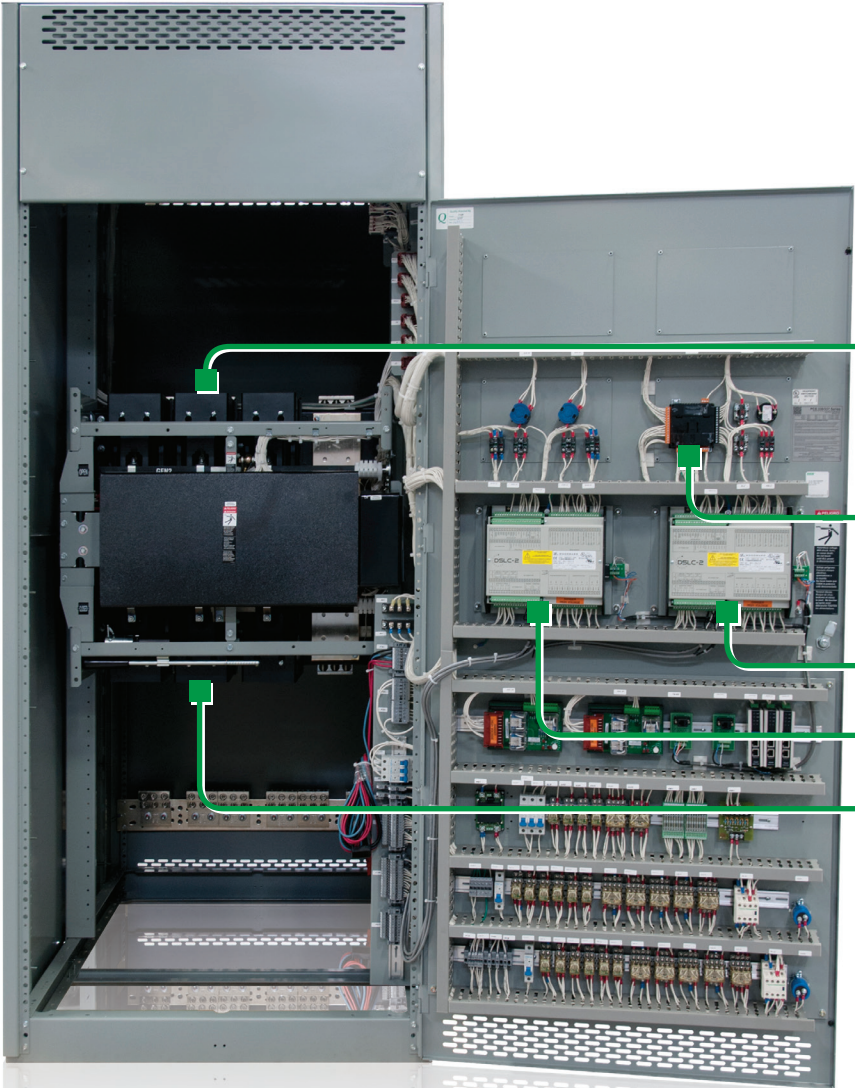
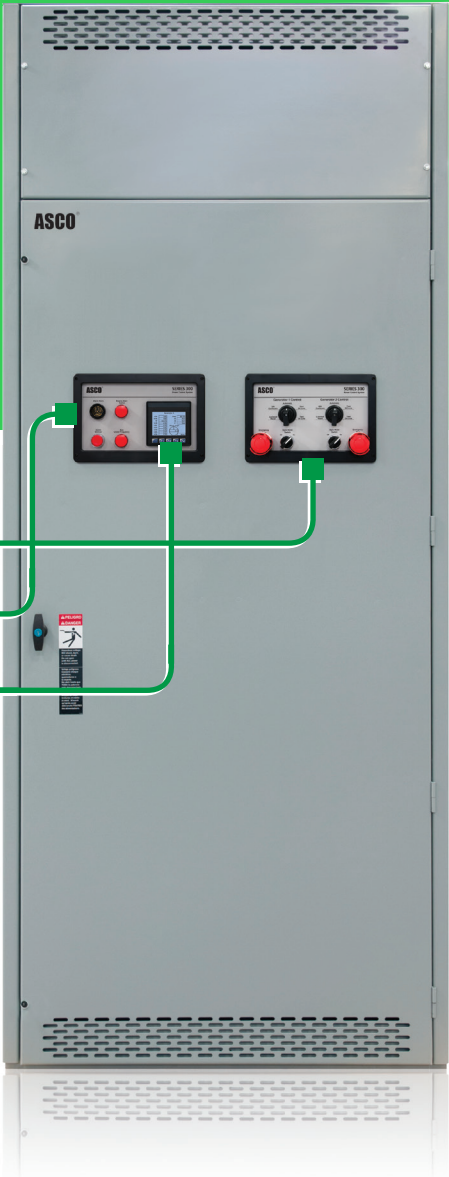

- Generator 2 Connections
- Graphic Touch Screen
- Generator 1
- Generator 2
- Generator 1 Connections



Control at your fingertips

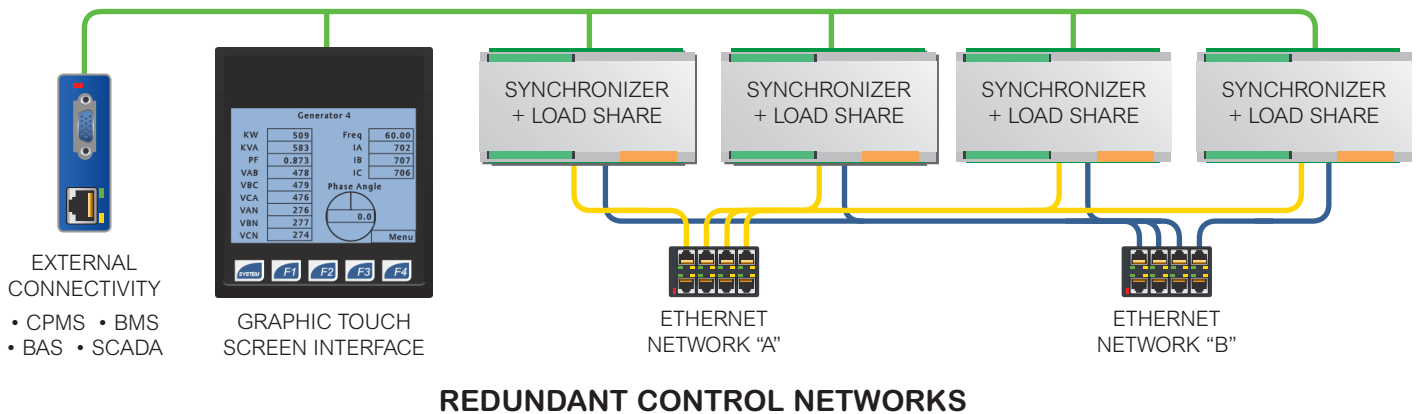

The Foundation for Reliability

The core paralleling switching mechanism of the SERIES 300 Paralleling System is a field proven ASCO Closed Transition Transfer Switch (CTTS). By combining the high reliability and long endurance life of the ASCO switching mechanism with advanced synchronizing and power management controls, the result is a robust, economical, compact, and effective paralleling system.

All the power controls, switching mechanisms, bus, metering and user controls are integrated into a compact UL 891 listed switchboard. This provides a more reliable system solution as critical components are independent and located separately from the engine-generator sets for ease of operation and service.

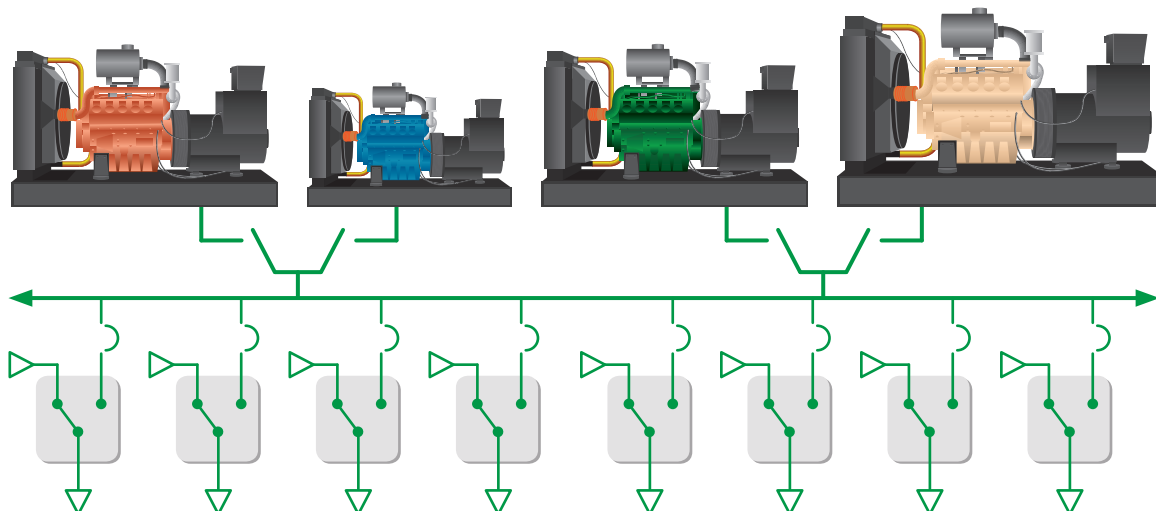

Power and Resource Management Tools

The ASCO history of innovation continues with the SERIES 300 Paralleling System. Innovative features such as managing generators by runtime usage, assigned priority, or load requirements, as well as distributing power according to prioritized loads, ensure power continuity from automatic controls. Additional features include the capability of adding and shedding loads as well as manual generator starts and connection to load bus via the generator control station.

Load Bus Optimization. Transfer switches are managed according to their priority blocks, with 4 priority blocks for a 2-generator system and 8 priority blocks for a 4-generator system. Loads can be separated and assigned to block priorities according to their importance, with the intent of operating all online generators at their maximum efficiency. This application will add or shed loads automatically according to the available capacity as determined by online generators. Operators can enable or disable this application via the graphic touch screen.

Generator Load Demand. Operators assign each generator a priority and select a management mode: runtime or priority management. The application adds or removes generators to/from the load bus, according to the operator's selected management mode, in order to operate all online generators as efficiently as possible according to the loads connected to the bus. Operators can enable or disable this application via the graphic touch screen as well.

Engine Generator Controls. In addition to automatic functions, operator controls for manual intervention include controls for manual paralleling (engine start, synchronize and connect to load bus), a manual selector switch for each generator (Lockout-Reset, Off-Cooldown, Automatic, Test Offline, and Test Online), Synchronizer Mode, and Emergency Stop.

Master Controls. In addition to the graphic touch screen logs, indicators and controls, discrete indicators include Bus Under-Frequency, Engine Start Active and an Alarm Horn. An Alarm Silence push-button allows the operator to acknowledge an alarm annunciation.

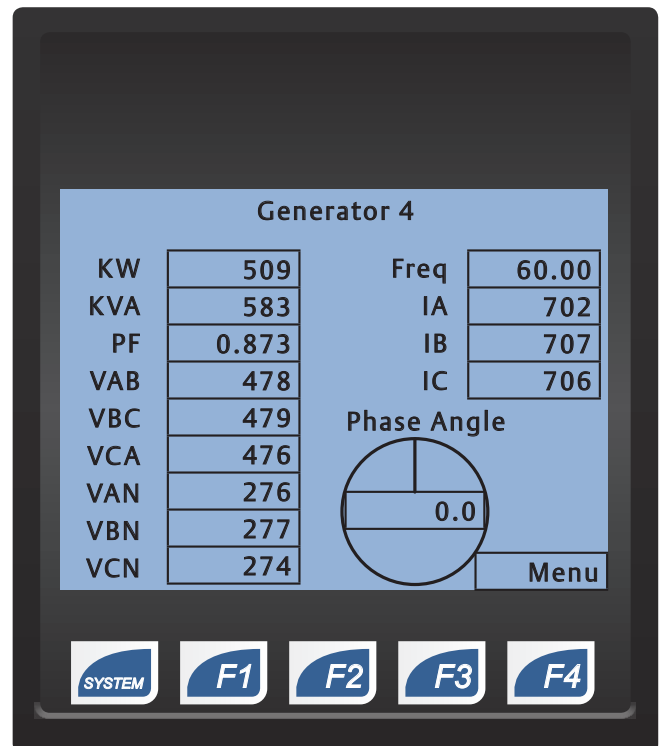

Parallel a Variety of Generators

Because the SERIES 300 System controls synchronization and load sharing via bias signals to the voltage regulator and governor, our solution is not limited to specific versions of generator controls or the same manufacturer, allowing for more flexible expansion options.

High Reliability

Putting together the most reliable switching mechanism with the most sophisticated paralleling controls utilizing redundant communication networks results in a robust and reliable paralleling solution. Add to that service and support groups dedicated to standby and critical power for a superior level of assurance.

Easily Expandable

The SERIES 300 Paralleling System brings an unprecedented level of simplified modularity and expandability to a variety of applications and generators. With front access options and a footprint as small as 28"D by 38"W, the SERIES 300 can be designed into compact power generation configurations with as many as 4 engine-generator sets.

Intuitive Operation

By bringing together in one location the paralleling controls for all generators and including a logical, easy to use graphic touch screen with intuitive fingertip selections, the SERIES 300 streamlines your operation and improves the reliability of your power for your application.

Fitting Your Application

The reliability, small footprint, flexible expandability and economic benefits make the SERIES 300 a perfect fit for a variety of applications.

Optional CPMS Bundles

Accessories 150PC1 and 150PC5 allows effective management of the SERIES 300 PCS master and generator controls as well as downstream transfer switches and metering. It remotely provides visibility and insight of your power system's health and performance.

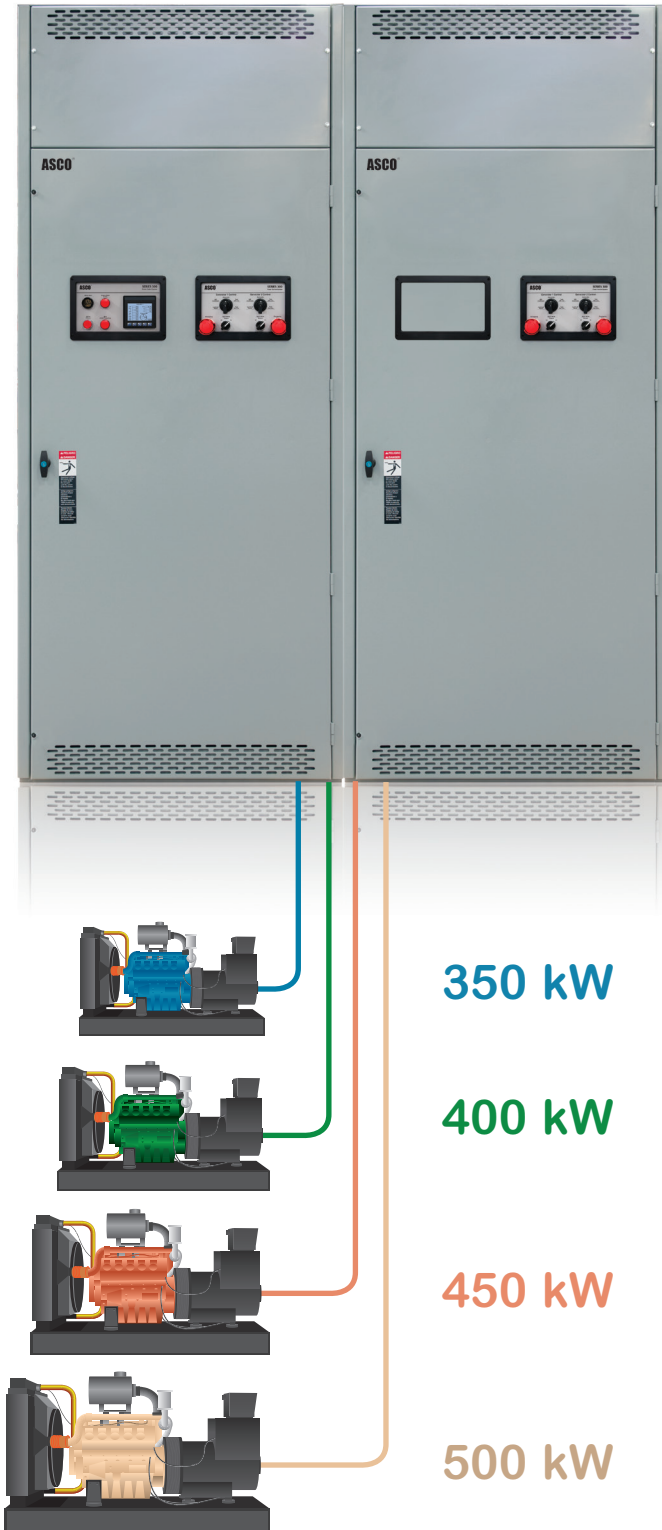

Accessory 150PC5 shown above (see ordering page for more info)

336 Ordering Information

G + 1 + 0 + 3 + 3 + 6 + A + 4 + 1200 + 4 + 4 + X + D												
Frame	1	0	SE-RIES	Paral-eling System	Model	Neutral	Poles	Bus Amps	Voltage*	# Gens	Accessory	Enclo- sure
H	1	0	3=300	3= ASCO Switch	6	0 = None A = Solid	3	0600 0800 1000 1200 2000 3000 4000	C = 208 H = 380 J = 400 N = 480 R = 600	2 3 4	0 = None X = Optional Accessories Z = custom distribution and optional accessories	C = Type 1 D = Type 1 extended depth M = Type 3R

Frame

The H frame is for units with “Bus Amps” of 600 amperes (“0600”) to 1200 amperes.

The G frame is for units with “Bus Amps” of 2000 to 4000 amperes.

Neutral

0 = No neutral bus (3 phase 3 wire systems)

A = A solid neutral is provided for continuous connection of all neutrals (3 phase 4 wire systems)

Bus Amps

Select aggregate current of both generators (divide by 2 for maximum current per generator)

Voltage

C = 3-phase 208/120 VAC

J = 3-phase 400/230 VAC

R = 3-phase 600/346 VAC

H = 3-phase 380/220 VAC

N = 3-phase 480/277 VAC

* Consult factory for other voltages

Gens

Select the total number of generators to be paralleled

Accessory

0 = No accessories

X = Optional accessory/accessories per standard list below

Z = Customized distribution (manually operated power circuit breakers with trip units) and optional accessories

Enclosure

C = Type 1 indoor enclosure as defined by UL

D = Type 1 Extended depth for cabling (automatically included for 3- and 4-generator systems)

M = Type 3R secure outdoor enclosure per UL; door gaskets, rain resistant vents, strip heater and thermostat (requires customer to supply external 120VAC)

336 Accessories

44A = Strip heater with thermostat wired to terminal block for Type 1 enclosures (requires customer supplied 120VAC)

73A__ = Surge arrestor on load per shaded box

131 = American Recovery and Reinvestment Act Compliance Certification

150PS = DC control power/ground isolation per generator

150TDI = Additional 7” color touch screen interface

150PC1 = CPMS bundle (monitoring, NFPA 110 compliance, e-mail alarms, BMS interface, 1 remote client, up to 16 monitored devices)

150PC5 = CPMS bundle (150PC1 plus Joint Commission reporting, event logging, historical trending, 3 remote clients, up to 32 monitored devices)

150EC = External communication (ModbusTCP for connectivity to BMS, BAS, SCADA, etc.)

G34 = Extended depth for bus expansion

73AB3 = 3 ø 3 wire delta (any voltage) 65KAIC

73AB6 = 3 ø 3 wire delta (any voltage) 80KAIC

73AC3 = 3 ø 4 wire wye (any voltage) 65KAIC

73AC6 = 3 ø 4 wire wye (any voltage) 80KAIC

336 Ordering Examples

Example 1: 2 Generators, 300 KW each, 480 V 3-Ph 60 Hz, solid neutral, no accessories, indoor

Catalog Order Number: H10336A31000N20C

Example 2: 4 Generators, 300 KW each, 480 V 3-Ph 60 Hz, no neutral, external communication, 80 KAIC surge arrestor (3 phase 4 wire wye), outdoor

Catalog Order Number: H10336031000N4XM, 73AC6, 150EC

Life Is On

Schneider
Electric™

ASCO Power Technologies - Global Headquarters
160 Park Avenue
Florham Park, NJ 07932
Tel: 800 800 ASCO

www.ascopower.com
customercare@ascopower.com

CED Raleigh
<https://www.cedraleigh.portalced.com>
(919) 828-9326
marketing@cedraleigh.com

Authorized Partner
The logo for CED Raleigh features the letters 'CED' in a large, bold, blue font. The letter 'C' is stylized with a sunburst or starburst pattern inside its upper curve. Below 'CED', the word 'RALEIGH' is written in a smaller, bold, blue, sans-serif font.